

R&S® HE300 Active Directional Antenna

R&S® HE300UK Upgrade Kit

Manual



4067.5945.32 – 08

This manual describes the following models and options:

- R&S®HE300 Active Directional Antenna 4067.5900.02
- R&S®HE300 Active Directional Antenna 4067.5900.03
- R&S®HE300UK Upgrade Kit 4080.9011.02

© 2010 Rohde & Schwarz GmbH & Co. KG

Muehldorfstr. 15, 81671 Munich, Germany

Phone: +49 89 41 29 - 0

Fax: +49 89 41 29 12 164

E-mail: info@rohde-schwarz.com

Internet: <http://www.rohde-schwarz.com>

Printed in Germany – Subject to change – Data without tolerance limits is not binding.

R&S® is a registered trademark of Rohde & Schwarz GmbH & Co. KG.

Trade names are trademarks of the owners.

The following abbreviations are used throughout this manual: R&S®HE300 is abbreviated as R&S HE300.

Contents

1	Characteristics.....	5
1.1	Use.....	5
1.2	Description.....	7
1.2.1	Antenna Modules.....	7
1.2.2	Supply and Display Unit.....	10
1.3	Specifications.....	11
1.4	Equipment Supplied.....	13
1.5	Recommended Extras.....	14
1.6	Ordering Information.....	14
2	Preparation for Use.....	15
2.1	Use of a Tripod.....	15
2.2	Assembling the Belt.....	15
2.3	Attaching the Belt to the Antenna.....	17
2.3.1	Attaching the Belt to the Handle.....	18
2.3.2	Attaching the Belt to the Handle and Antenna Module.....	19
2.4	Power Supply.....	21
2.4.1	External Voltage Supply.....	21
2.4.2	Batteries.....	22
3	Operation.....	23
3.1	Operating Elements.....	23
3.2	Exchanging the Antenna Module.....	26
3.3	Switching the Built-in Broadband Amplifier On and Off.....	26
3.4	External Voltage Supply.....	27
3.5	Battery Test.....	28
3.6	Replacing the Batteries.....	28
3.7	Notes on Practical Use.....	30
3.7.1	How to hold the R&S HE300.....	30
3.7.2	How to use the Compass.....	31
4	Maintenance.....	33
4.1	Maintenance and Repair.....	33

4.1.1	Maintenance.....	33
4.1.2	Disassembly and Reassembly.....	33
4.1.3	Functional Check.....	33
4.1.4	Storage and Transport.....	33
5	Diagrams and Patterns.....	35
5.1	Typical Radiation Patterns.....	38
5.1.1	Antenna Module 20 MHz to 200 MHz.....	38
5.1.2	Antenna Module 200 MHz to 500 MHz.....	39
5.1.3	Antenna Module 500 MHz to 7.5 GHz.....	40
5.1.4	Diagrams and Patterns for the R&S HE300 with R&S HE300HF.....	41
5.1.5	Typical Radiation Patterns of the optional Antenna Module R&S HE300HF.....	43
6	List of Appendices.....	45

1 Characteristics

1.1 Use

The handy and extremely broadband Active Directional Antenna R&S HE300 in conjunction with portable receivers (e.g. R&S PR100) is used for localizing transmitting and interfering sources. The direction of signal sources is found by pointing the antenna towards the direction of maximum signal voltage.

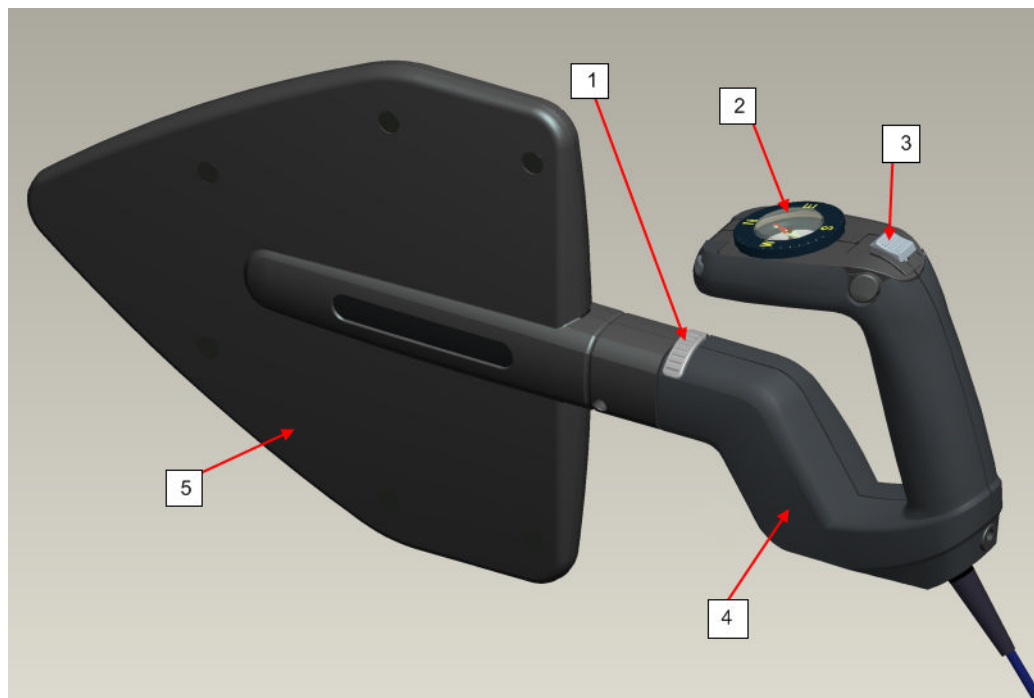

Fig. 1-1: System overview (model 02).

- 1 = Release switch (releases/locks the antenna module)
- 2 = Compass
- 3 = Toggle switch (internal amplifier ON / OFF)
- 4 = Supply and display unit
- 5 = Antenna module

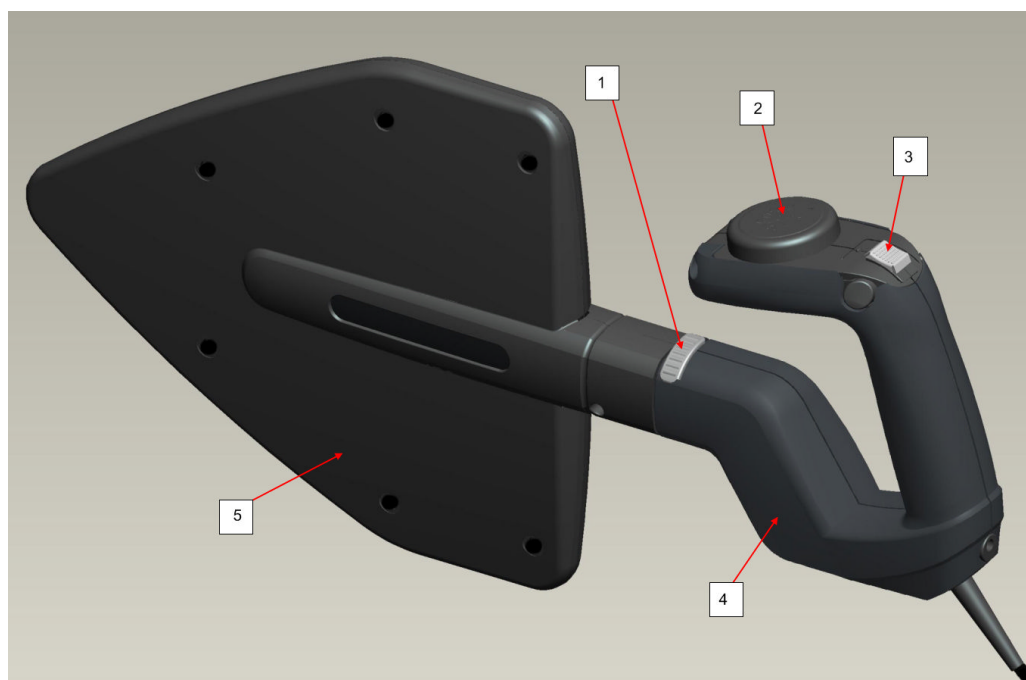

Fig. 1-2: System overview (model 03).

- 1 = Release switch (releases/locks the antenna module)
- 2 = GPS/Electronic compass unit
- 3 = Toggle switch (internal amplifier ON / OFF)
- 4 = Supply and display unit
- 5 = Antenna module

The overall frequency range from 9 kHz to 7.5 GHz is covered by four exchangeable antenna modules, each with a distinct directional pattern. The modules do not have to be tuned within their frequency sub-ranges. Delivery of the R&S HE300 includes three of these modules; the fourth module (R&S HE300HF for 9 kHz to 20 MHz) is available as an option.

A built-in low-noise broadband amplifier can be activated in order to increase the system's sensitivity ("Active" mode).

In "Passive" mode, the amplifier is bypassed and the R&S HE300 may also be used in the vicinity of strong transmitters.

NOTICE

Incorrect use of the system

Use of the system for purposes other than those stated in this chapter may result in personal injury or damage to the equipment or other property.

The R&S HE300 is characterized by the following features:

- Unambiguous direction finding, i.e. distinct directional pattern with the receive maximum pointing to the front in the frequency range from 20 MHz to 7.5 GHz.
- The maximum of the antenna output signal serves as a directional criterion (maximum direction finding).

- Handy size despite extreme broadband capability.
- Fatigue-free operation due to the antenna design and the material used, which keep weight to a minimum.
- May be used for vertical and horizontal polarization in the frequency range from 20 MHz to 7.5 GHz.
- Wide dynamic range due to switchable "Passive" and "Active" mode.
- May be mounted on a tripod (1/4" mounting thread).
- Power supply by standard AA batteries or rechargeable batteries.

1.2 Description

1.2.1 Antenna Modules

The operating frequency range of 20 MHz to 7.5 GHz is covered by three exchangeable antenna modules:

Frequency range	Antenna module
20 MHz to 200 MHz	Antenna module 4067.6306.00 (loaded loop antenna with broadband cardioid directional pattern)
200 MHz to 500 MHz	Antenna module 4067.6606.00 (loaded loop antenna with broadband cardioid directional pattern)
500 MHz to 7500 MHz	Antenna module 4067.6458.00 (log-periodic dipole antenna with a nearly frequency-independent directional pattern)

A fourth antenna module is available as an option for the lower frequency range from 9 kHz to 20 MHz:

Frequency range	Antenna module
9 kHz to 20 MHz	Antenna module R&S HE300HF 4067.6806.02 (loop antenna, not included in delivery)

The module selected for the task at hand is plugged into the supply and display unit and locked in position. The modules can be plugged in for both vertical and horizontal polarization.



Fig. 1-3: R&S HE300 with antenna module 20 MHz to 200 MHz.

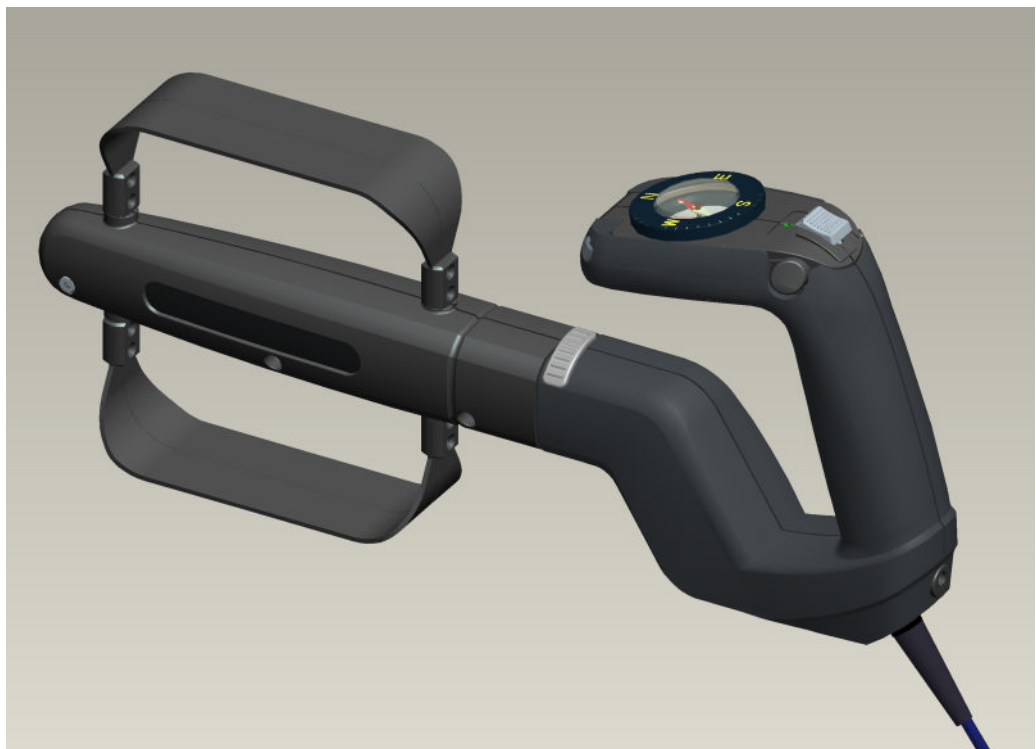

Fig. 1-4: R&S HE300 with antenna module 200 MHz to 500 MHz.

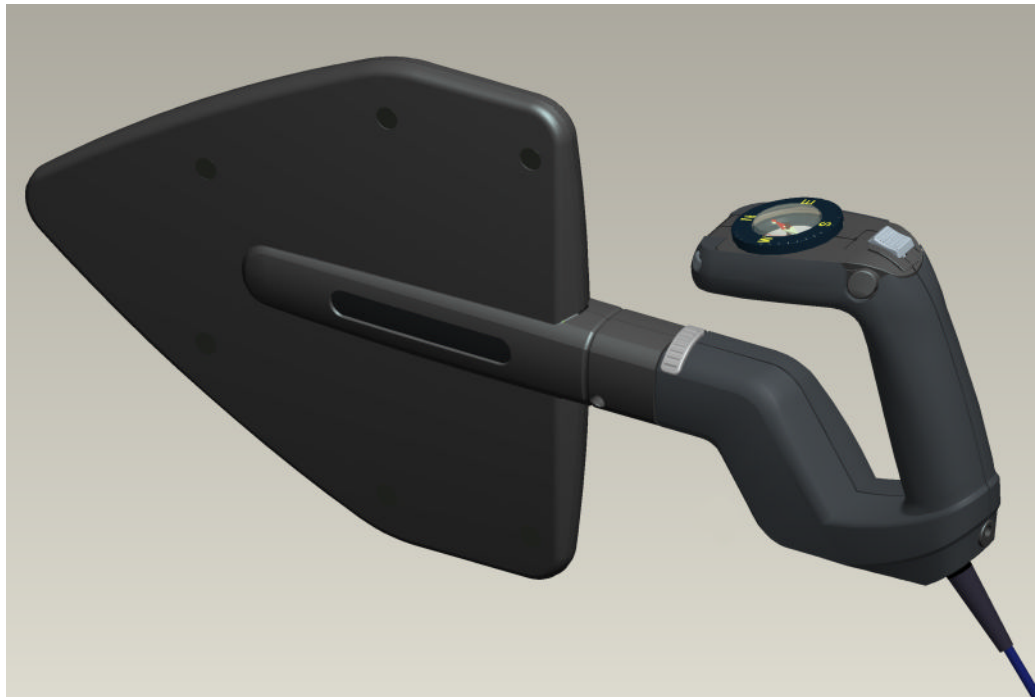

Fig. 1-5: R&S HE300 with antenna module 500 MHz to 7.5 GHz.



Fig. 1-6: R&S HE300 with optional antenna module R&S HE300HF 9 kHz to 20 MHz.

**Note on the frequency range 9 kHz to 20 MHz**

As antenna module R&S HE300HF is designed as a loop antenna, vertical polarization (normal handling position) leads to two receive maxima, one in the direction of the signal source and the other at an angle of 180° to it (see also [figure 5-17](#)).

In order to determine the direction of arrival of a particular signal in vertical polarization (vertical loop), direction finding must take place from at least two different sites. The transmitter is then found at the intersection point of the respective DF beams.

With horizontal polarization (horizontal loop), the direction cannot be determined as the radiation pattern in azimuth is circular.

1.2.2 Supply and Display Unit

Two different models of R&S HE300 are available which differ in the supply and display unit:

- Model 02 contains a supply and display unit which comprises the following modules:
 - Compass with turnable graduation ring
 - Antenna electronics with built-in low-noise amplifier
 - Toggle switch for switching between "Active" and "Passive" mode
- Model 03 contains a supply and display unit which comprises the following modules:
 - Electronic compass module
 - GPS receiver module with patch antenna
 - Antenna electronics with built-in low-noise amplifier
 - Toggle switch for switching between "Active" and "Passive" mode with the additional feature to detect the state of the switch by the connected receiver, e.g. R&S PR100
 - Microcontroller unit for data transfer to R&S PR100 via a serial interface

**Note on R&S HE300UK**

R&S HE300UK upgrade kit contains all hardware to upgrade R&S HE300 model 02 to model 03.

In "Passive" mode the low-noise amplifier is bypassed and has no supply voltage. "Passive" mode is thus also possible without batteries or external voltage supply.

**Note on "Active" and "Passive" mode**

The R&S HE300 should only be switched to "Active" mode if there are no strong transmitters in close vicinity and the sensitivity of the receiving system (antenna with receiver) in "Passive" mode is not sufficient to detect the signal.

When the amplifier is activated, a green LED on the rear of the supply and display unit indicates that the battery voltage or external supply voltage is within the permissible range. If this LED goes off, you must replace the batteries or check the external voltage supply.

R&S HE300 model 03 reports the activation of the amplifier via the control cable for further processing by a connected receiver, e.g. R&S PR100.

1.3 Specifications

Frequency range	20 MHz to 7.5 GHz with the three supplied plug-in antenna modules
<ul style="list-style-type: none"> • Antenna module 4067.6306.00 Loaded loop antenna • Antenna module 4067.6606.00 Loaded loop antenna • Antenna module 4067.6458.00 Log-periodic antenna • Option 4067.6806.02 Loop antenna • Supply and display unit 	<p>20 MHz to 200 MHz</p> <p>200 MHz to 500 MHz</p> <p>500 MHz to 7.5 GHz</p> <p>9 kHz to 20 MHz</p> <p>9 kHz to 7.5 GHz</p>
Polarization	Horizontal und vertical for all antenna modules. Selection of polarization by turning the longitudinal antenna axis by 90° prior to connecting it to the supply and display unit.
Nominal impedance	50 Ω
VSWR	< 2.5 typ. (excluding R&S HE300HF module)
RF output	Cable at the handle, approx. 1 m in length N connector
Internal amplifier	<ul style="list-style-type: none"> • Power consumption $I_{cc} = 40 \text{ mA}$ $V_D = 3.6 \text{ V}$ • Noise figure 5.3 dB at 2 GHz • Output IP3 +26 dBm 2 GHz ± 100 kHz $P_{\text{Tone}} = -5 \text{ dBm}$ • Output $P_{1\text{dB}}$ +11.7 dBm at 2 GHz • Input RF-Power max. 13 dBm
Gain	for typical values see figure 5-1 , figure 5-2 and figure 5-13
Antenna factor	for typical values see figure 5-3 , figure 5-4 and figure 5-14
Field strength sensitivity	for typical values see figure 5-5 , figure 5-6 and figure 5-15

Typical directional patterns <ul style="list-style-type: none"> • 20 MHz to 200 MHz • 200 MHz to 500 MHz • 500 MHz to 7.5 GHz • Option: 9 kHz to 20 MHz 	<p>for typical values see figure 5-8 and figure 5-9</p> <p>for typical values see figure 5-10 and figure 5-11</p> <p>for typical values see figure 5-12</p> <p>for typical values see figure 5-17</p>
Power supply <ul style="list-style-type: none"> • Batteries • Rechargeable batteries • External voltage supply • Permissible voltage range • Current drain 	<p>6 dry cells (1.5 V, size AA) in the handle</p> <p>6 AA rechargeable batteries in the handle (1.2 V)</p> <p>8 V (via connector EXT. POWER)</p> <p>7 V to 9 V DC</p> <p>approx. 100 mA in "Active" mode (25 °C)</p> <p>0 mA in "Passive" mode</p>
MTBF according to SN29500 ground benign, 45 °C	<p>R&S HE300 mod. 02 > 1 500 000 hours</p> <p>R&S HE300 mod. 03 > 100 000 hours</p>
Dimensions The maximum dimensions apply to the R&S HE300 with antenna module 20 MHz to 200 MHz. The other modules give smaller dimensions. <ul style="list-style-type: none"> • max. length • max. width • max. depth 	<p>580 mm</p> <p>310 mm</p> <p>90 mm</p>
Weight <ul style="list-style-type: none"> • total weight (including transport case and auxiliaries) • max. operational weight (with Antenna module 20 MHz to 200 MHz) 	<p>approx. 7 kg</p> <p>approx. 1.5 kg</p>
Temperature ranges <ul style="list-style-type: none"> • Operating temperature range • Nominal temperature range • Storing temperature range 	<p>-30 °C to +55 °C</p> <p>-10 °C to +50 °C</p> <p>-30 °C to +60 °C</p>
Vibration resistance according to DIN EN 60068-2-64	<p>Random 10 Hz to 300 Hz: 0.01 g²/Hz</p> <p>300 Hz to 500 Hz: 0.003 g²/Hz</p> <p>every 30 minutes in the three orthogonal axes; acceleration approx. 1.9 g_{rms}</p>
Shock resistance according to MIL-STD 810 E-method 516.4 procedure I	<p>max. 40 g, crossover frequency 45 Hz in three orthogonal axes</p>

GPS/Electronic compass unit	
(only applicable for R&S HE300 model 03 and R&S HE300UK)	
Power supply	5 V +/- 0.2 V (delivered by R&S PR100 via control cable)
Current consumption	max. 100 mA
Connector type	7-pin male cable connector
GPS	
• Acquisition time (cold start)	approx 40 sec (measured with good visibility of satellites and -125 dBm signal strength)
• Refresh rate	1 Hz
Electronic compass	
• Available data	Azimuth and elevation
• Accuracy (accuracy data is valid for optimum surroundings without metallic obstacles in the vicinity of the antenna)	typ. 2° RMS for 0° Elevation typ. 4° RMS for +/- 60° Elevation
• Data resolution	1°

1.4 Equipment Supplied

Delivery of the R&S HE300 includes:

- 1 supply and display unit with compass (R&S HE300 mod. 02) or GPS/Electronic compass module (R&S HE300 mod. 03)
- 3 antenna modules
- 1 set of batteries
- 2 battery holders
- 1 transport case
- 1 carrying belt
- 1 manual (CD-ROM)
- Safety instructions and customer information (printed)

Delivery of R&S HE300UK includes:

- 1 supply and display unit with GPS/Electronic compass module
- 1 set of batteries
- 1 battery holder
- 1 manual (CD-ROM)
- Safety instructions and customer information (printed)

1.5 Recommended Extras

The following extras are recommended:

Receiver R&S PR100	order number 4071.9006.02
Additional antenna module for lower frequency range	R&S HE300HF loop antenna 9 kHz to 20 MHz order number 4067.6806.02
Wooden tripod R&S HZ-1	order number 0837.2310.02
Battery charger	available in specialist shops
Cable-mounted socket for low voltages	available in specialist shops (e.g. Schurter: connector 6.5x4.3 mm, pin 1.4 mm JSBP5, order number 4840.1230)

1.6 Ordering Information

R&S HE300 model 02	Active Directional Antenna Order number 4067.5900.02
R&S HE300 model 03	Active Directional Antenna with GPS/Electronic compass module Order number 4067.5900.03
Optional: R&S HE300HF	Loop Antenna as HF option for R&S HE300 Order number 4067.6806.02
R&S HE300UK	GPS/Electronic compass Upgrade Kit for R&S HE300 model 02 Order number 4080.9011.02

2 Preparation for Use

2.1 Use of a Tripod

The R&S HE300 has a ¼" tripod mount in the lower part of the handle, which is suitable for attachment to a tripod, e.g. R&S HZ-1, or a similar commercial tripod. The antenna is fastened to the tripod via the tripod's fastening screw.

2.2 Assembling the Belt

Upon delivery the belt is disassembled. It consists of the following components:

- 1 belt
- 2 fastening straps

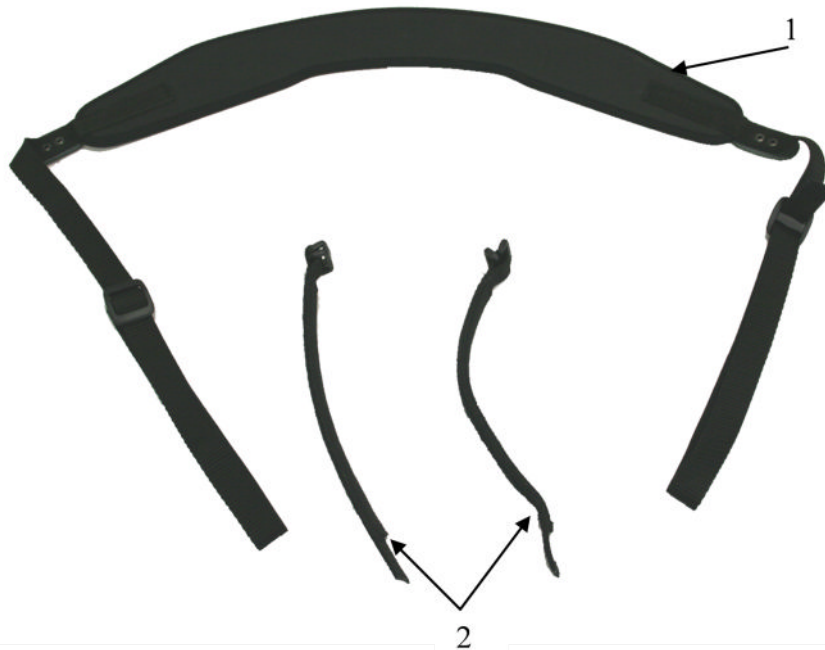

Fig. 2-1: Belt (1) and fastening straps (2).

- Attach the two fastening straps to the belt as shown in , [figure 2-2](#), [figure 2-3](#) and [figure 2-4](#).



Make sure you insert the end of the belt in the plastic fastener facing away from the neoprene (see red arrow in [figure 2-2](#)).

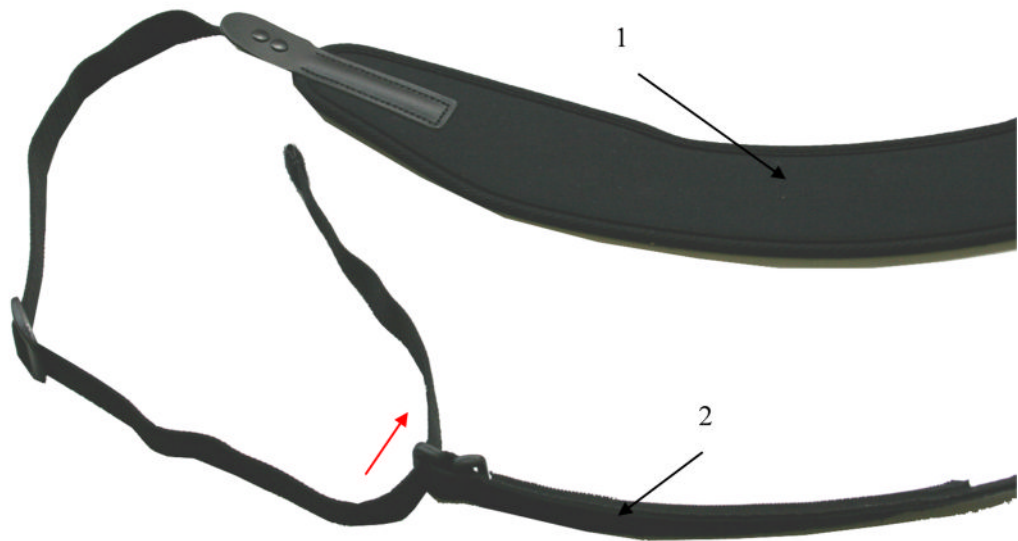

Fig. 2-2: Attaching the fastening strap, step 1.

1 = Belt
2 = Fastening strap

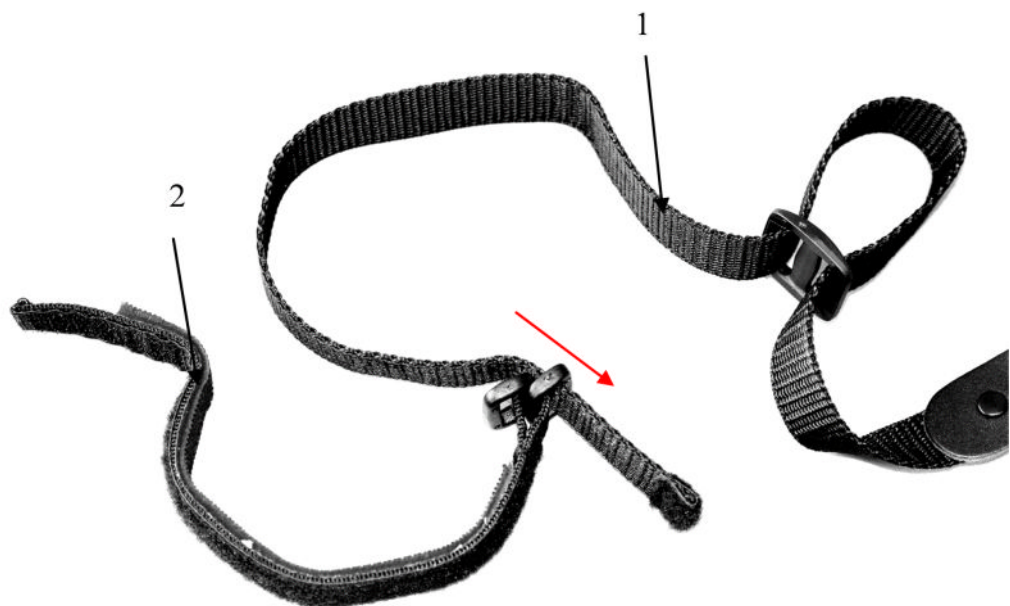

Fig. 2-3: Attaching the fastening strap, step 2.

1 = Belt
2 = Fastening strap

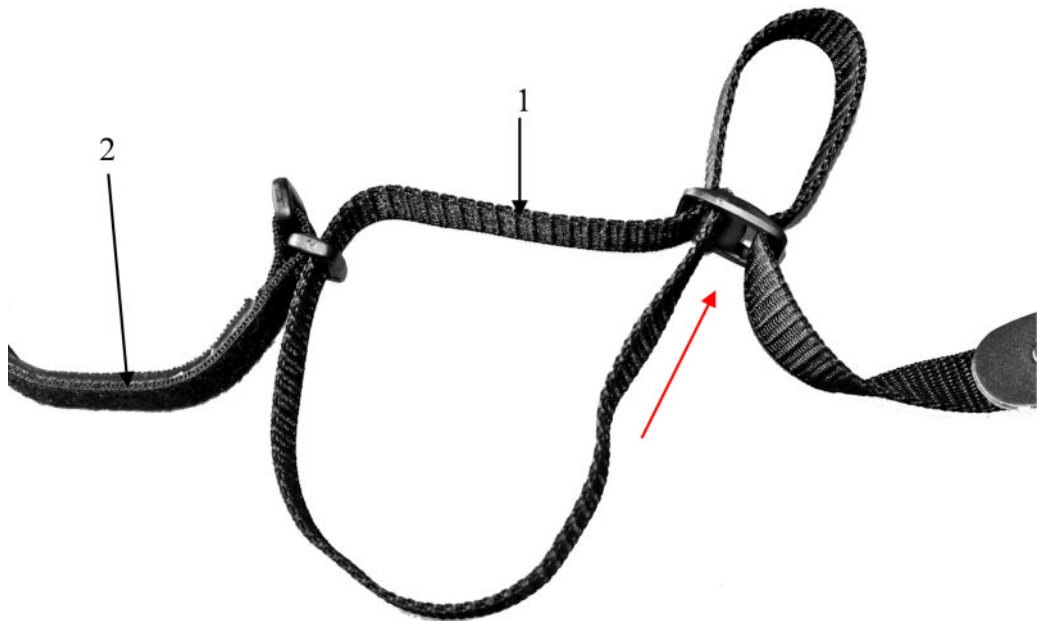

Fig. 2-4: Attaching the fastening strap, step 3.

1 = Belt
2 = Fastening strap

2.3 Attaching the Belt to the Antenna

Attach one of the fastening straps to the handle. Attach the other strap in either of the two ways described below:

1. Attach it to the handle at the antenna module mount, see [chapter 2.3.1, "Attaching the Belt to the Handle"](#), on page 18.
2. Attach it to the antenna module flange, see [chapter 2.3.2, "Attaching the Belt to the Handle and Antenna Module"](#), on page 19.

If you attach the strap to the handle you do not have to change it when you plug in a different antenna module. However, this requires a bit more handling effort when you align the antenna.

Attaching the strap to the antenna module flange results in more balanced handling and requires less effort when you align the antenna. However, you will have to re-attach the strap every time you plug in a different antenna module.

While one option gives you more carrying comfort, the other allows you to change antenna modules faster. This is a matter of personal preference.

2.3.1 Attaching the Belt to the Handle

Both fastening straps must be attached to the handle:

- Attach the rear strap to the upper end of the actual handle.
- Attach the forward strap to the antenna module mount behind the release switch.

1. Place the handle onto the neoprene sides of the fastening straps (see [figure 2-5](#)).



Fig. 2-5: Attaching the belt to the handle, step 1.

- 1 = belt
- 2 = rear fastening strap
- 3 = handle
- 4 = forward fastening strap
- 5 = release switch

2. Move the loose end of the strap through the plastic fastener (see [figure 2-6](#)).



Fig. 2-6: Attaching the belt to the handle, step 2.

1 = rear fastening strap

2 = forward fastening strap (as shown here, behind the release switch to allow a quick change of modules)

3. Bend the strap around behind the plastic fastener and attach it firmly to the velcro strip.

2.3.2 Attaching the Belt to the Handle and Antenna Module

- Attach the rear fastening strap to the upper end of the actual handle (see [figure 2-5](#)).
- Attach the forward fastening strap to the rear end of the antenna module flange (see [figure 2-6](#)).

When the antenna module is plugged into the handle, the forward fastening strap is located just in front of the release switch (see [figure 2-7](#), no. 2).

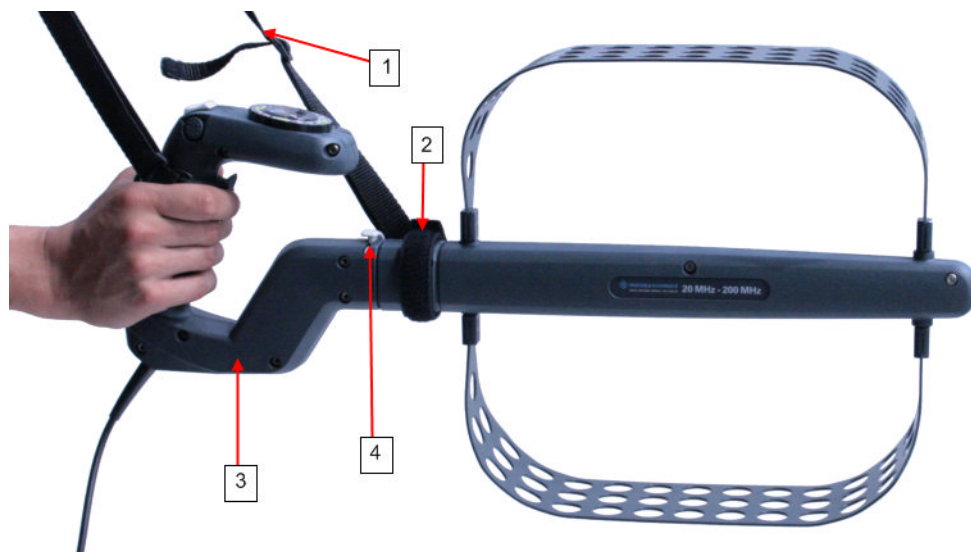

Fig. 2-7: Attaching the belt to the antenna and antenna module.

- 1 = belt
- 2 = forward fastening strap
- 3 = handle
- 4 = release switch



Always attach the fastening strap outside the antenna module loops!

If you attach the forward strap within the antenna module loops, it will be located within the antenna's effective area and thus affect the antenna's characteristics.

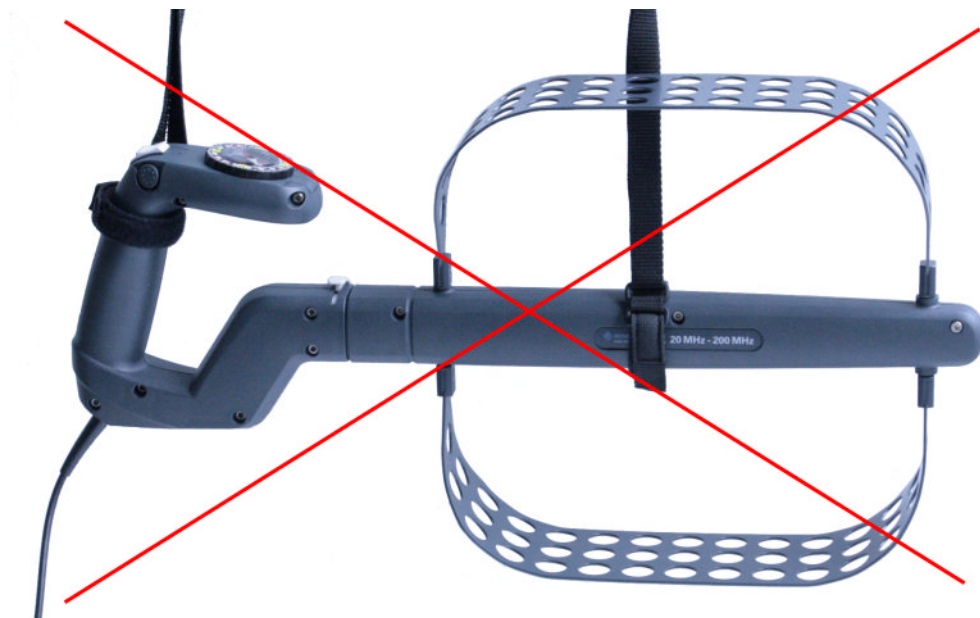

Fig. 2-8: Incorrect belt attachment.

- 1 = fastening strap inside the antenna module loops

2.3.2.1 Correct Position of the Carrying Belt

When you use the belt, make sure the longer side, i.e. the side with the more pronounced curve, faces inwardly. The neoprene side of the shoulder pad should rest on your shoulder (see red arrow in [figure 2-9](#)).



Fig. 2-9: Correct position of the carrying belt: longer side facing inwardly, neoprene side resting on the shoulder.

2.4 Power Supply

2.4.1 External Voltage Supply

An external voltage supply can be connected to connector EXT. POWER (voltage range 7 V to 9 V) located on the handle of the supply and display unit, see [figure 3-3](#). The batteries need not be removed when an external voltage supply is connected.

⚠ CAUTION

Make sure to use a correct connection:

DC supply

7 V DC to 9 V DC , 100 mA

positive polarity: center 

A connector for low voltages is available in specialist shops (e.g. Schurter: connector 6.5x4.3 mm, pin 1.4 mm JSBP5, order no. 4840.1230).



If an external voltage supply is connected, the batteries are not charged.



Note on R&S HE300 model 03 and R&S HE300UK

The external voltage supply does not supply the GPS/Electronic compass module. The supply for this unit is delivered by an appropriate receiver, e.g. R&S PR100 via the control cable.

2.4.2 Batteries

The six batteries are contained in a special holder within the unit's handle.

Rechargeable batteries must be charged externally by means of a commercial battery charger (not included in delivery).



Note on R&S HE300 model 03 and R&S HE300UK

The batteries do not supply the GPS/Electronic compass module. The supply for this unit is accomplished by an appropriate receiver, e.g. R&S PR100 via the control cable.

3 Operation

3.1 Operating Elements

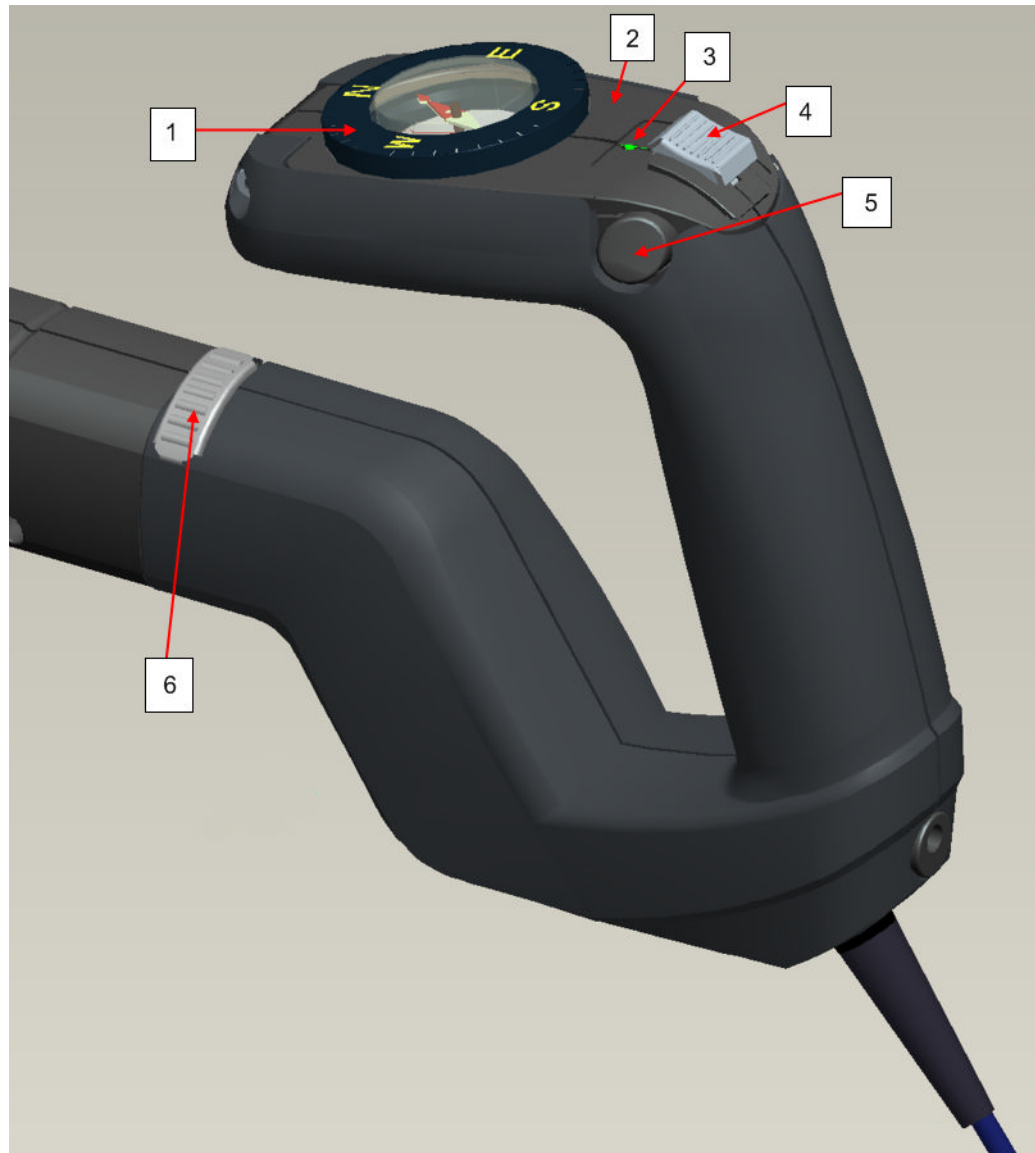

Fig. 3-1: R&S HE300 model 02: Operating elements on the supply and display unit .

- 1 = Compass
- 2 = Cover (battery holder)
- 3 = LED
- 4 = Toggle switch
- 5 = Cover release button
- 6 = Release switch (locks/releases the antenna module)

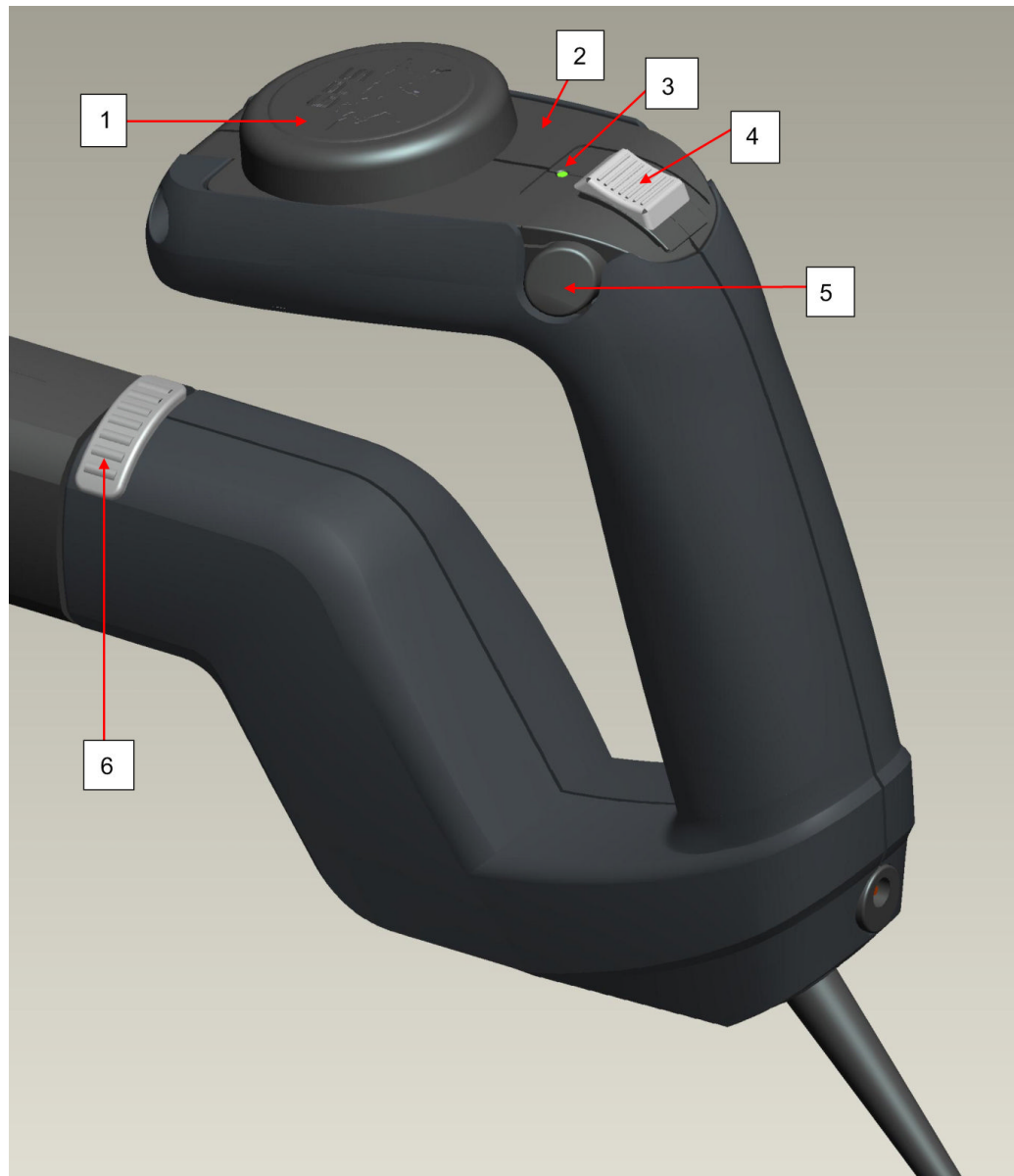

Fig. 3-2: R&S HE300 model 03, R&S HE300UK: Operating elements on the supply and display unit .

- 1 = GPS/Electronic compass module
- 2 = Cover (battery holder)
- 3 = LED
- 4 = Toggle switch
- 5 = Cover release button
- 6 = Release switch (locks/releases the antenna module)

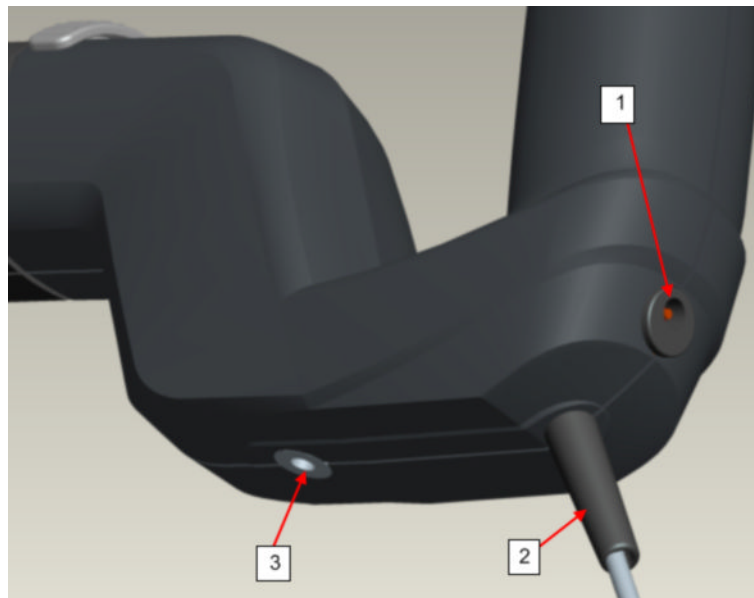

Fig. 3-3: R&S HE300 models 02/03, R&S HE300UK: Operating elements on the supply and display unit (detailed view) .

- 1 = DC socket (external voltage supply)
- 2 = Cable to receiver (1.5 m)
- 3 = Tripod mount

⚠ CAUTION

The cable to the receiver (see [figure 3-3](#), no. 2) is a sensitive RF cable. Bending in excess of the specified cable bending radius of 50 mm will cause permanent damage to the device.

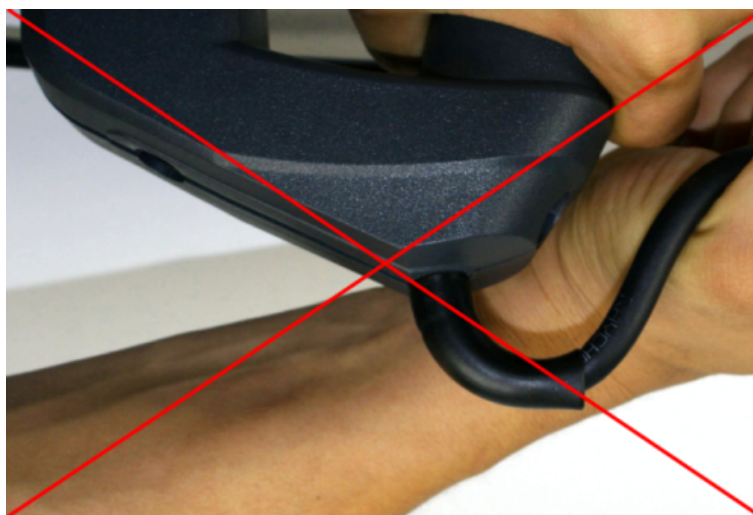

Fig. 3-4: Excessive bending of RF cable will cause permanent damage to the device.

3.2 Exchanging the Antenna Module

1. Slide the release switch on the handle to the left (see [figure 3-5](#), no. 2).
2. Pull out the antenna module.
3. Insert the desired module in horizontal or vertical position.
4. Slide the release switch back to the locked position (see [figure 3-5](#), no. 1)

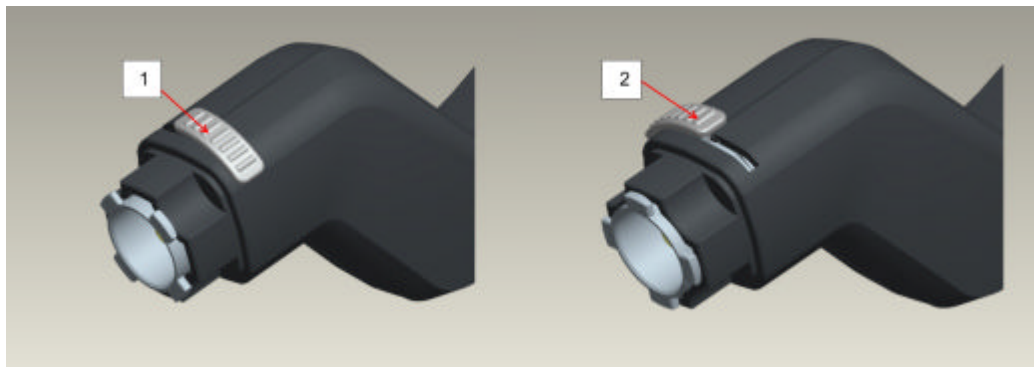

Fig. 3-5: Release switch.

1 = locked
2 = unlocked

3.3 Switching the Built-in Broadband Amplifier On and Off

"Passive" mode:

- Put the toggle switch on the handle of the supply and display unit into position "OFF" (downwards on the handle, see [figure 3-6](#)). The amplifier is switched off and no power is consumed.

"Active" mode:

- Place the toggle switch into position "ON" (upper position, see [figure 3-6](#)). The amplifier is switched on.

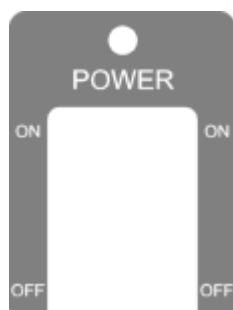

Fig. 3-6: Power label "ON" - "OFF".

**Note on R&S HE300 model 03 and R&S HE300UK:**

The state of the toggle switch is detected by the internal microcontroller and forwarded to the connected receiver, e.g. R&S PR100. This ensures correct display of the field-strength values.



The toggle switch remains in its position. Position "ON"/"Active" (power consumption) must be changed manually to switch off the amplifier.

3.4 External Voltage Supply

The external voltage supply allows detached operation, e.g. on a tripod.

CAUTION**Make sure to use a correct connection:**

DC supply

7 V DC to 9 V DC , 100 mA

positive polarity: center 

- Feeding supply voltage to the unit: via connector EXT. POWER (voltage range 7 V to 9 V) on the handle of the supply and display unit (see [figure 3-3](#), no. 1). There is no need to remove the batteries when connecting an external voltage supply.
- Place the toggle switch on the handle into position "ON" (see [figure 3-6](#)). Switchover between "Passive" and "Active" can now also be done by switching the external voltage supply on and off (remote control) since the connector for the external voltage supply interrupts the battery circuit.
- After removing the connector for the external voltage supply, place the toggle switch on the handle into position "OFF" (see [figure 3-6](#)). If this is not done, the antenna electronics and the amplifier will continually be fed by the batteries.



After disconnecting the external voltage supply, put the toggle switch on the handle of the supply and display unit into position "OFF". If you fail to do so the antenna electronics and internal amplifier will continually be fed by the batteries.

**Note on R&S HE300 model 03 and R&S HE300UK:**

The external voltage supply does not supply the GPS/Electronic compass module. The supply for this unit is delivered by the connected receiver, e.g. R&S PR100 via the control cable.

3.5 Battery Test

If the green LED beside the toggle switch on the handle does not light up when you activate the amplifier, the supply voltage is too low or the batteries are exhausted.

3.6 Replacing the Batteries

1. Press the two cover release buttons on the handle simultaneously and open the cover by pulling (see Fig. [figure 3-7](#)). The battery holder is now accessible (see [figure 3-8](#)).
2. Remove the holder with the exhausted batteries.
3. Insert new or recharged batteries.
4. Insert the battery holder as indicated by the mark. Make sure you position the contacts properly (see [figure 3-9](#)). The handle's contacts are visible within the handle.
5. Close the cover.

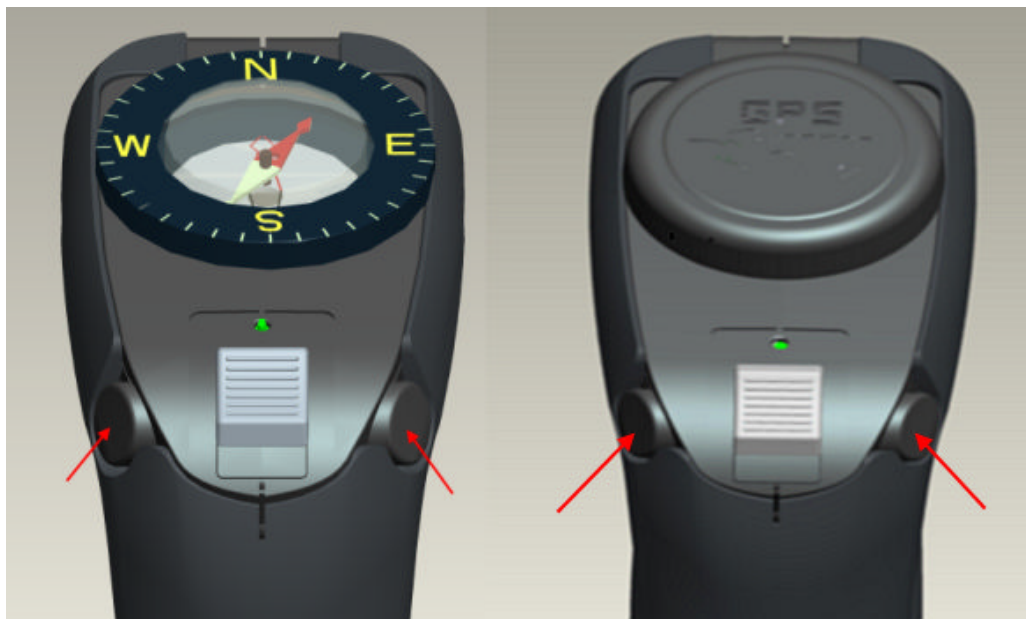

Fig. 3-7: Cover release buttons (left : model 02, right : model 03).



Fig. 3-8: Cover open.

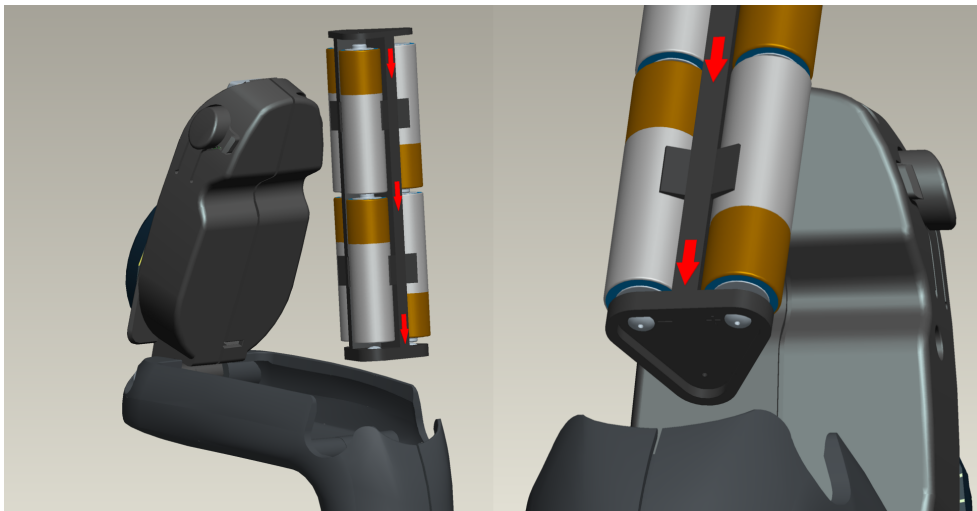

Fig. 3-9: Insert battery holder as indicated.



You will need a commercial battery charger to charge the batteries. Delivery of R&S HE300 or R&S HE300UK does not include a battery charger.

3.7 Notes on Practical Use

3.7.1 How to hold the R&S HE300

To ensure optimum DF results, you have to carry the R&S HE300 with your arm stretched out for locating the maximum.

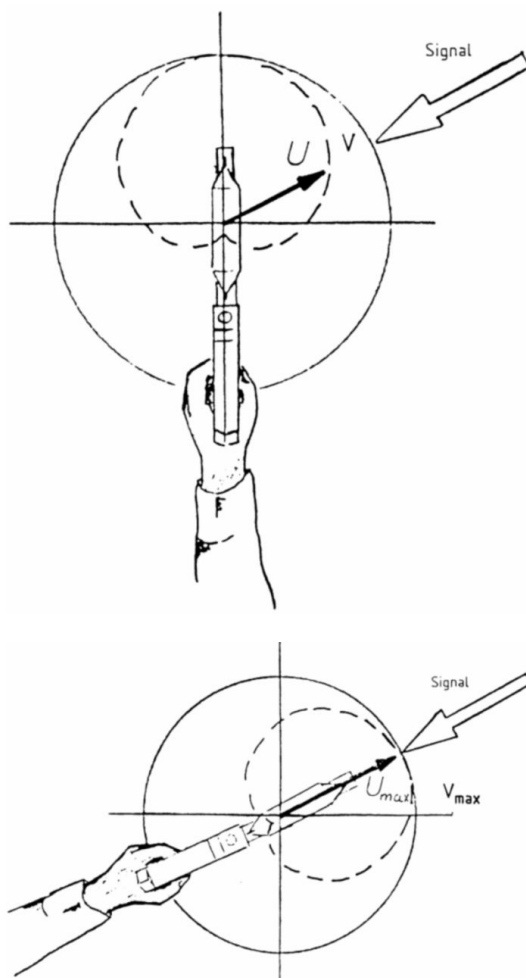

Fig. 3-10: Manual direction finding by locating the maximum.

The center of rotation should be located in the antenna rather than your body. Moving the antenna to and fro is unfavorable since the search for maximum reception is impaired by site-dependent level differences occurring in disturbed electromagnetic fields.

If an unambiguous maximum is not obtained in a closed room, for example, the interference due to reflections is too high and the site has to be changed.

Reflections and interference occur if electromagnetic waves come into contact with objects that have a high dielectric constant or are conductive.

In a disturbed environment, direction finding should best be carried out from several sites, approaching the transmitter gradually (see figure 3-11).

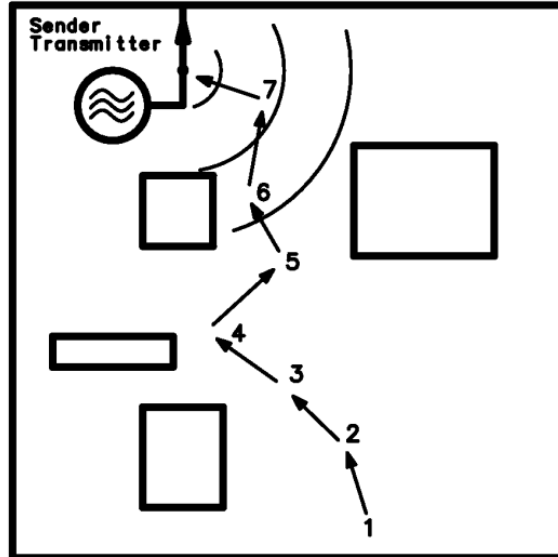

Fig. 3-11: Locating a transmitter in a closed room with strong interference of the electromagnetic field.

3.7.2 How to use the Compass



Fig. 3-12: Compass (model 02).

- 1 = compass needle
- 2 = graduation ring (turnable)
- 3 = transparent arrow (at the bottom of the compass)
- 4 = groove

Model 02:

1. Hold the R&S HE300 horizontally in front of you. Make sure that it points towards your destination (e.g. the located maximum).
2. Turn the graduation ring until the red end of the compass needle points to the marker "N" on the graduation ring (red end of compass needle will be aligned now to the transparent arrow at the bottom of the compass).
3. Now you can see the direction of your destination, i.e. the degrees indicated. It is easiest to look at the groove as the latter coincides with the antenna axis (see [figure 3-12](#)).



Note on R&S HE300 model 03 and R&S HE300UK

Electronic compass and GPS functionality can only be utilized in conjunction with an appropriate receiver, e.g. R&S PR100 receiver. Please refer to the R&S PR100 manual for further information.

4 Maintenance

4.1 Maintenance and Repair

4.1.1 Maintenance

If the batteries used are not leak-proof, the battery holder must be checked at short intervals. If the R&S HE300 is not used for a longer period of time, remove the batteries from the antenna.

Clean the battery holder contacts carefully if they are soiled.

4.1.2 Disassembly and Reassembly

⚠ CAUTION**Disassembly and reassembly**

Any disassembly/reassembly must be performed by skilled and authorized technical personnel observing the regulations for electrostatic sensitive devices.

4.1.3 Functional Check

If the green LED beside the toggle switch on the handle does not light up when you activate the amplifier, the supply voltage is too low or the batteries are exhausted.

4.1.4 Storage and Transport

The R&S HE300 should only be stored and transported in the supplied transport case, according to [figure 4-1](#).



Fig. 4-1: Transport case - Placement of the R&S HE300 equipment .

- 1 = Optional antenna module 9 kHz to 20 MHz (not included in delivery)
- 2 = Antenna module 200 MHz to 500 MHz
- 3 = Antenna module 20 MHz to 200 MHz
- 4 = Antenna module 500 MHz to 7.5 GHz
- 5 = Receiver R&S PR100 (not included in delivery)
- 6 = Supply and display unit
- 7 = Manual (CD-ROM)
- 8 = Battery holder
- 9 = Set of batteries
- 10 = Carrying belt

5 Diagrams and Patterns

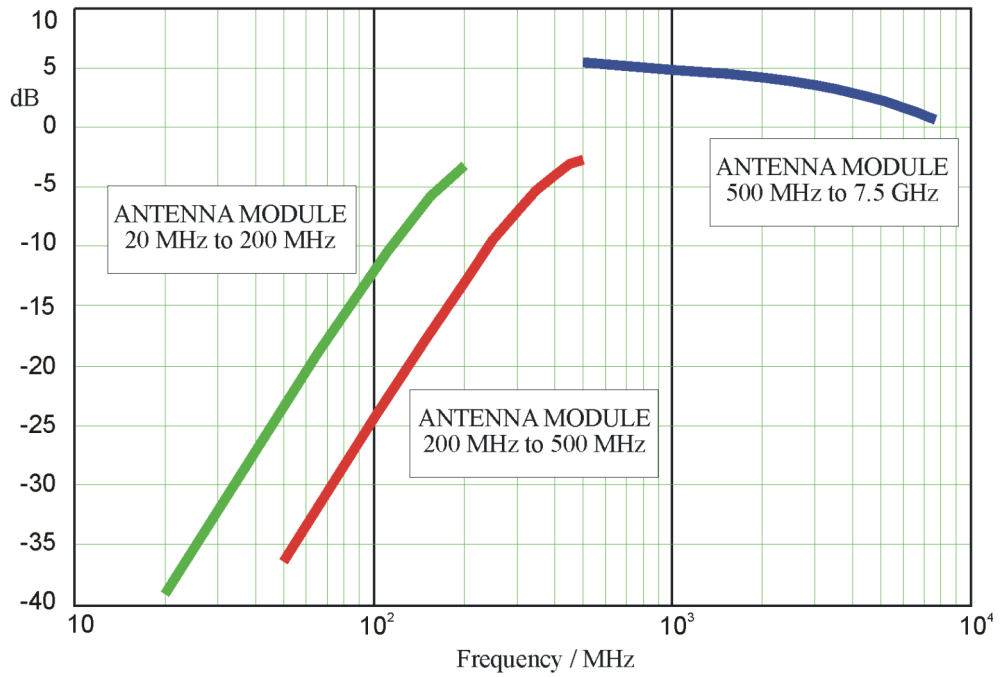

Fig. 5-1: Gain, "Passive" mode.

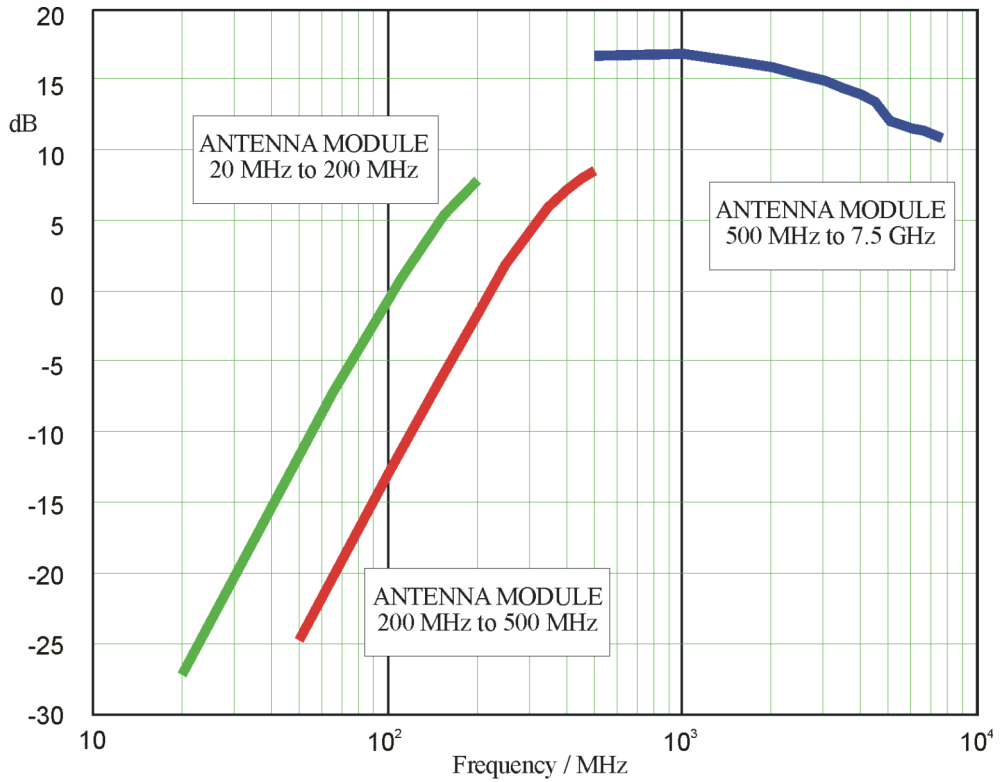

Fig. 5-2: Gain, "Active" mode.

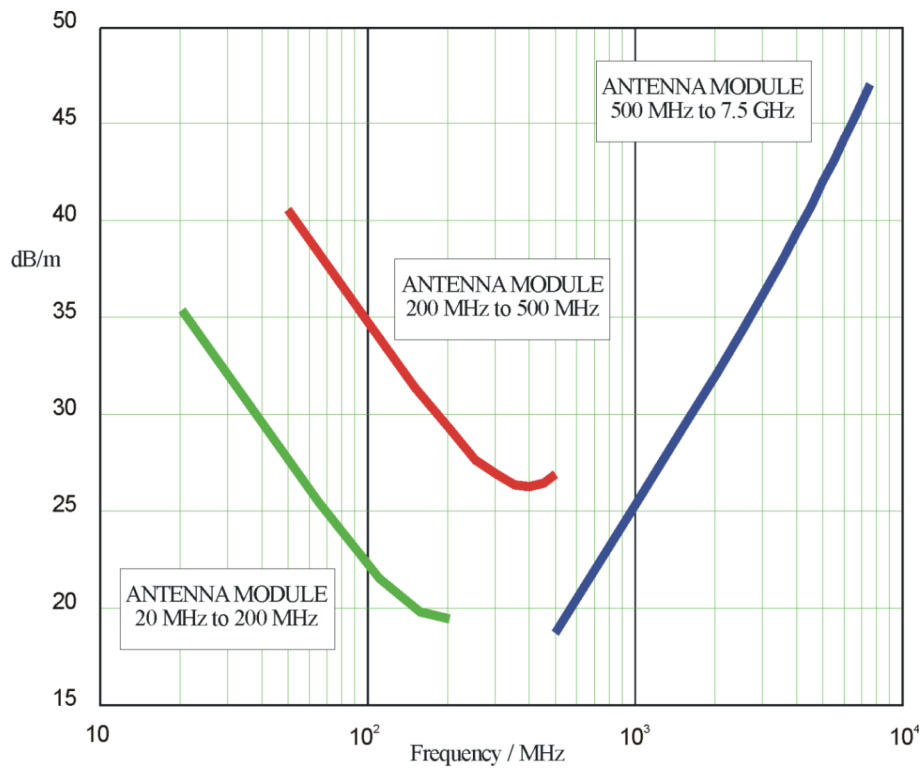

Fig. 5-3: Antenna factor, "Passive" mode.

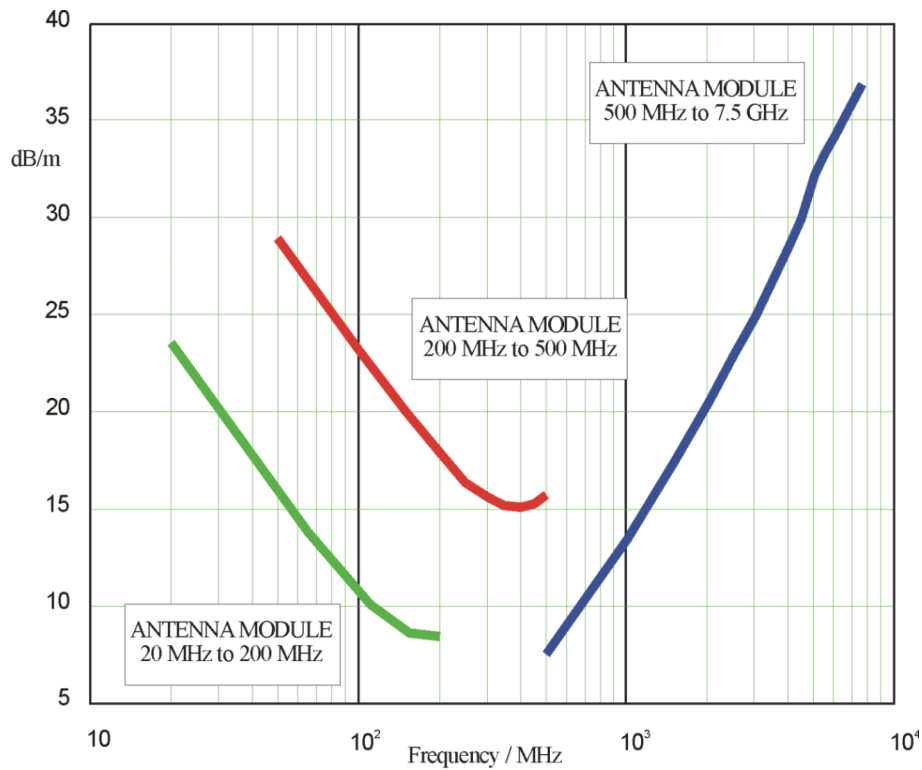

Fig. 5-4: Antenna factor, "Active" mode.

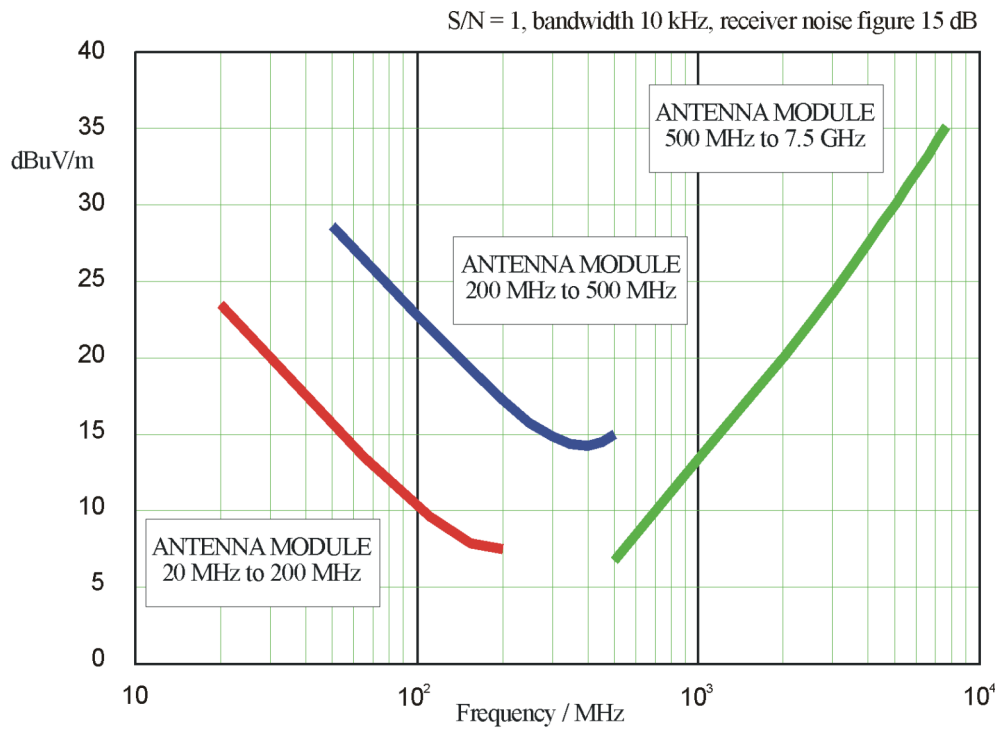

Fig. 5-5: Absolute sensitivity, "Passive" mode.

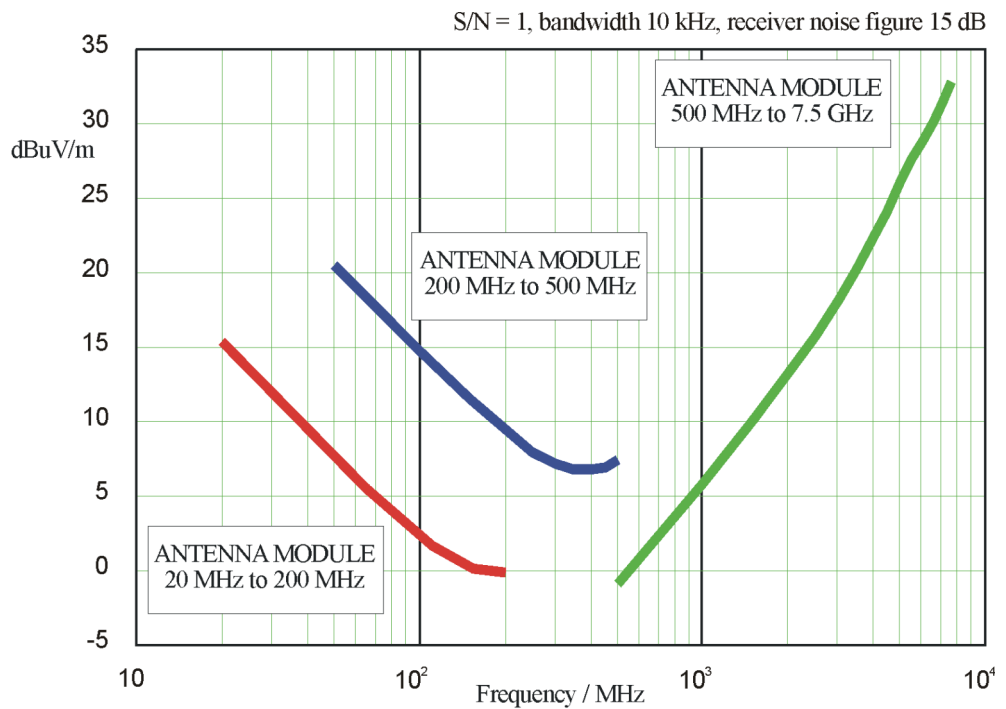

Fig. 5-6: Absolute sensitivity, "Active" mode.

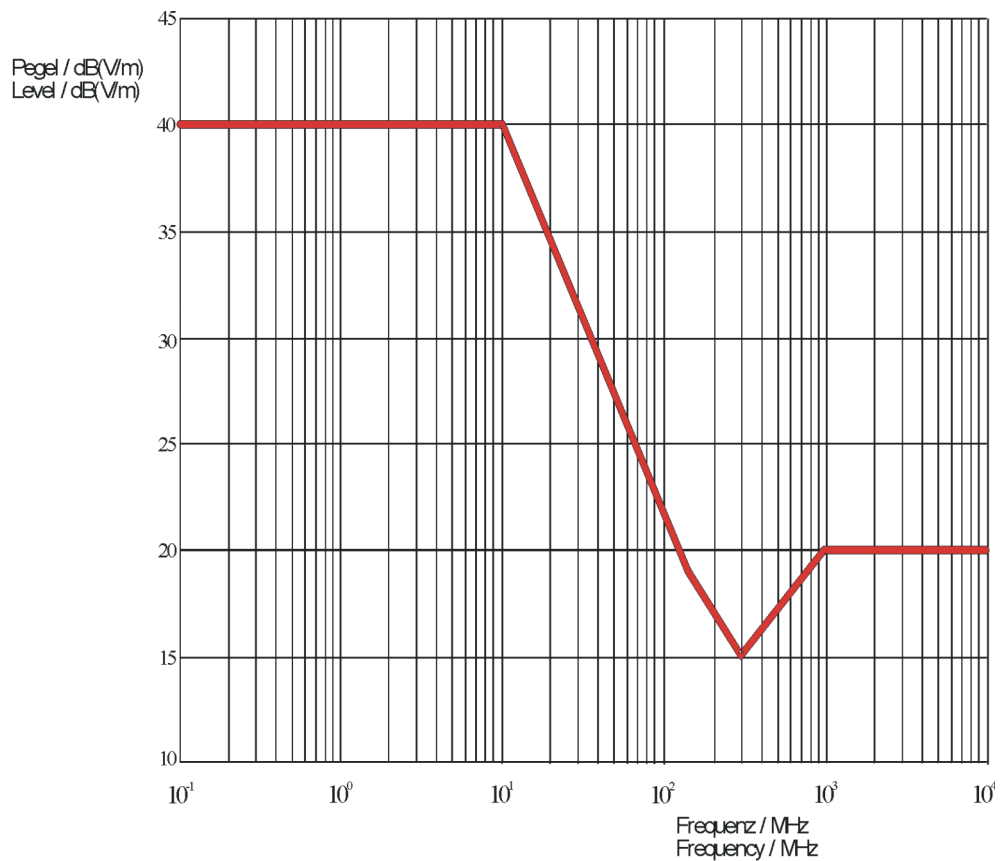

Fig. 5-7: Destructive field strength, "Active" mode (valid for all standard antenna modules).



Note on R&S HE300 model 03 and R&S HE300UK:

In the frequency range 1575 MHz +/- 50 MHz max. -14dB (V/m) allowed.

5.1 Typical Radiation Patterns

5.1.1 Antenna Module 20 MHz to 200 MHz

Patterns apply to normal handling position (handle upright).





If the antenna module is turned by 90° when connected, the horizontal and vertical patterns will be switched.

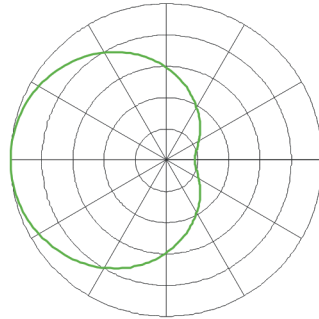

Horizontaldiagramm
Frequenz: 20 MHz
Horizontal pattern
Frequency: 20 MHz

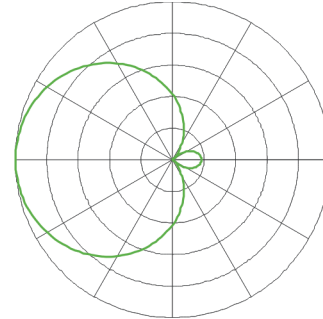

Vertikaldiagramm
Frequenz: 20 MHz
Vertical pattern
Frequency: 20 MHz

Fig. 5-8: Radiation patterns, 20 MHz (antenna module 20 MHz to 200 MHz).

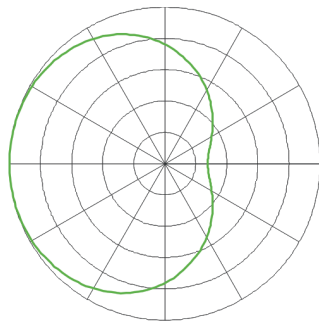

Horizontaldiagramm
Frequenz: 200 MHz
Horizontal pattern
Frequency: 200 MHz

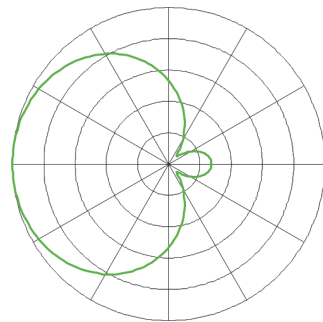

Vertikaldiagramm
Frequenz: 200 MHz
Vertical pattern
Frequency: 200 MHz

Fig. 5-9: Radiation patterns, 200 MHz (antenna module 20 MHz to 200 MHz).

5.1.2 Antenna Module 200 MHz to 500 MHz

Patterns apply to normal handling position (handle upright).



If the antenna module is turned by 90° when connected, the horizontal and vertical patterns will be switched.

Typical Radiation Patterns

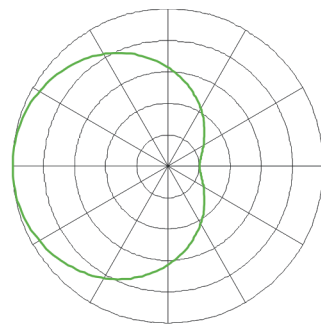

Horizontaldiagramm
Frequenz: 200 MHz
Horizontal pattern
Frequency: 200 MHz

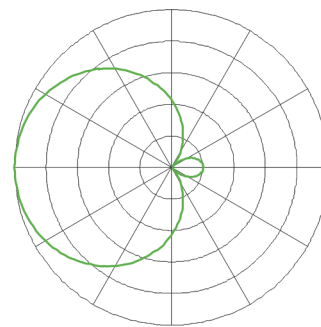

Vertikaldiagramm
Frequenz: 200 MHz
Vertical pattern
Frequency: 200 MHz

Fig. 5-10: Radiation patterns, 200 MHz (antenna module 200 MHz to 500 MHz).

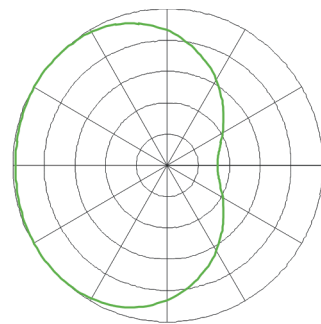

Horizontaldiagramm
Frequenz: 500 MHz
Horizontal pattern
Frequency: 500 MHz

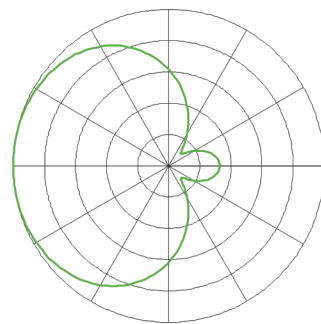

Vertikaldiagramm
Frequenz: 500 MHz
Vertical pattern
Frequency: 500 MHz

Fig. 5-11: Radiation patterns, 500 MHz (antenna module 200 MHz to 500 MHz).

5.1.3 Antenna Module 500 MHz to 7.5 GHz

Patterns apply to normal handling position (handle upright).



If the antenna module is turned by 90° when connected, the horizontal and vertical patterns will be switched.

Typical Radiation Patterns

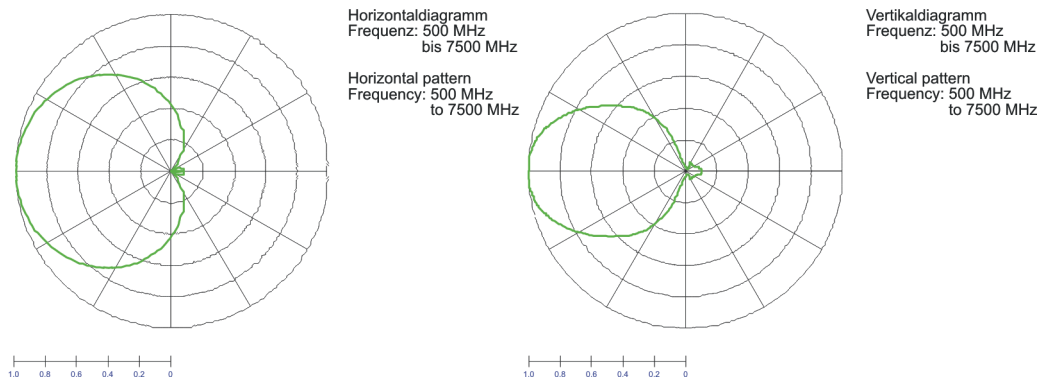

Fig. 5-12: Radiation patterns, antenna module 500 MHz to 7.5 GHz.

5.1.4 Diagrams and Patterns for the R&S HE300 with R&S HE300HF

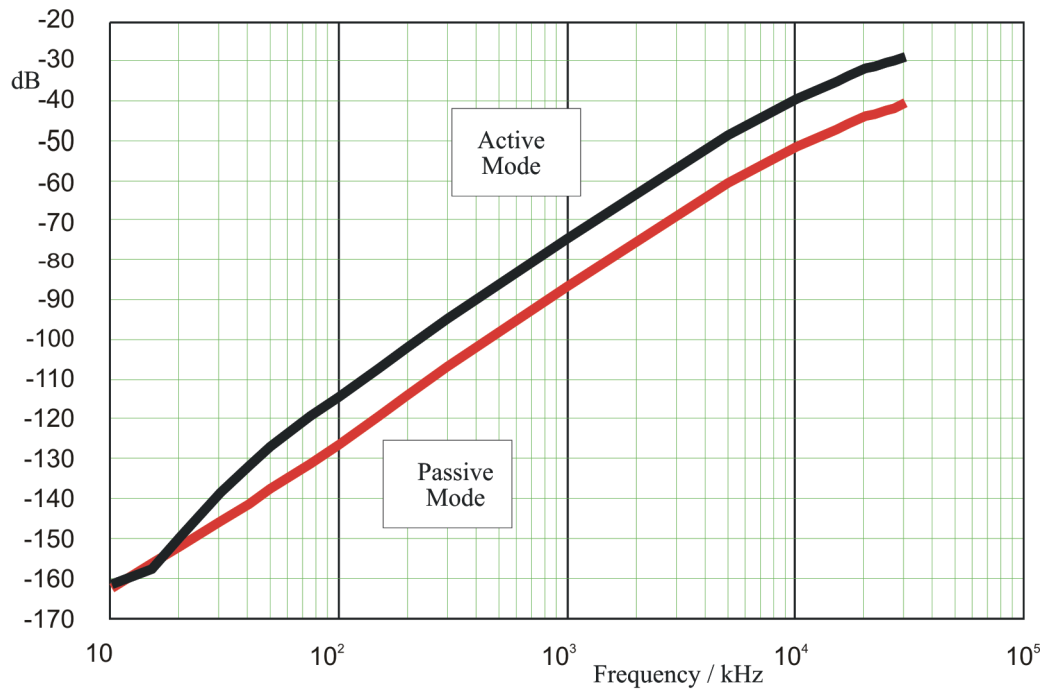

Fig. 5-13: Gain of the R&S HE300 with R&S HE300HF.

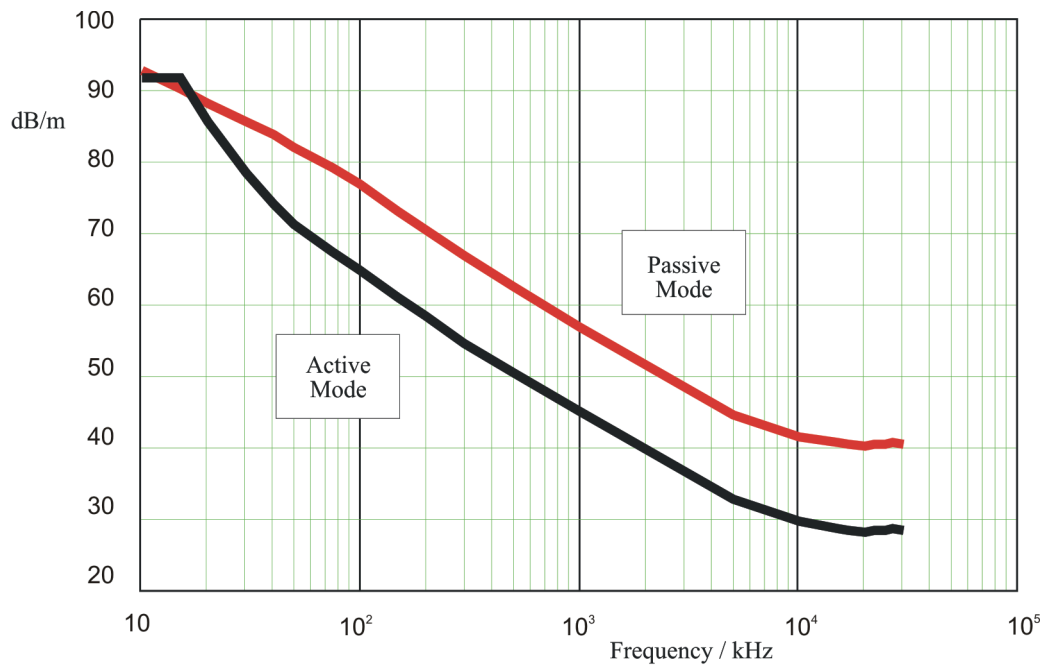

Fig. 5-14: Antenna factor of the R&S HE300 with R&S HE300HF.

S/N = 1, bandwidth 10 kHz, receiver noise figure 15 dB

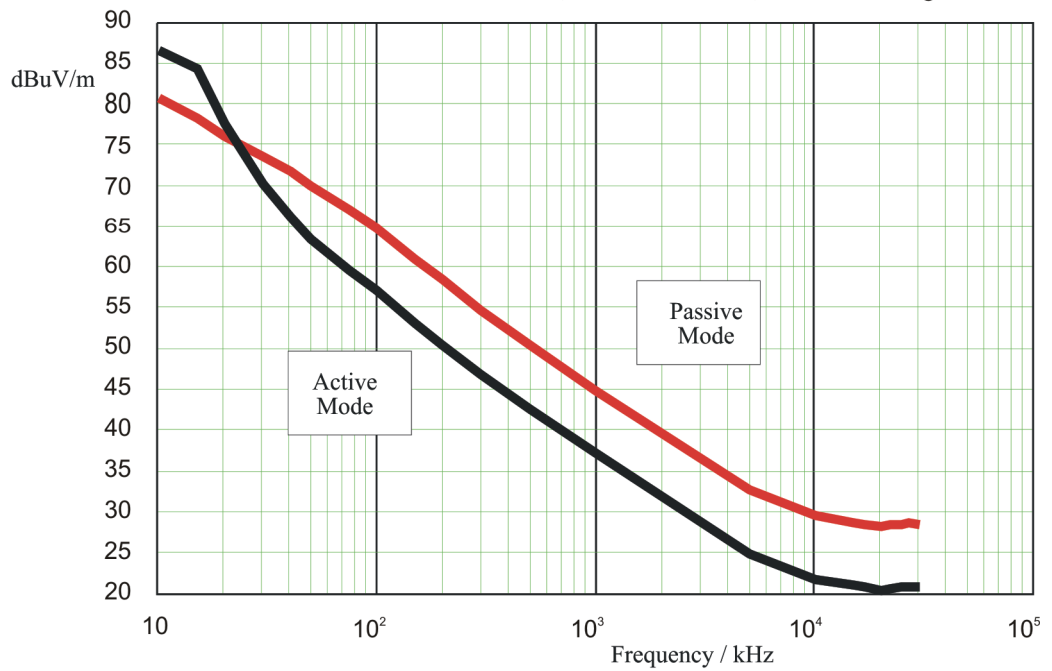

Fig. 5-15: Absolute sensitivity of the R&S HE300 with R&S HE300HF.

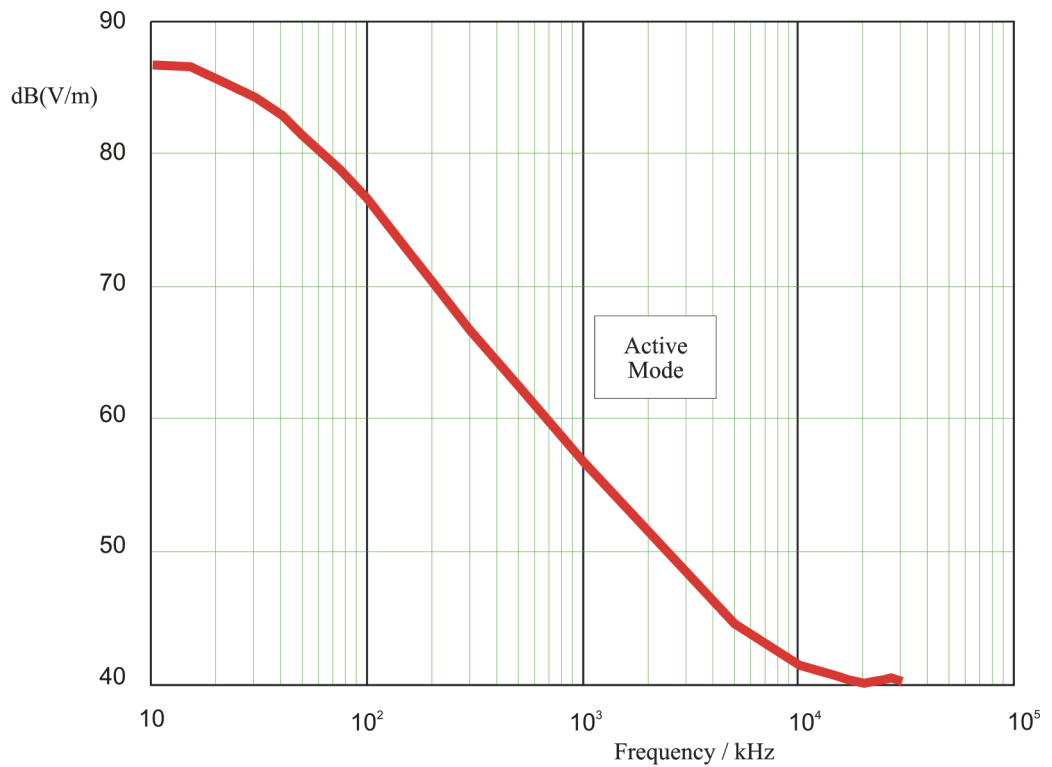

Fig. 5-16: Destructive field strength of the R&S HE300 with R&S HE300HF.

5.1.5 Typical Radiation Patterns of the optional Antenna Module R&S HE300HF

Patterns apply to normal handling position (handle upright).



If the antenna module is turned by 90° when connected, the horizontal and vertical patterns will be switched.

Typical Radiation Patterns

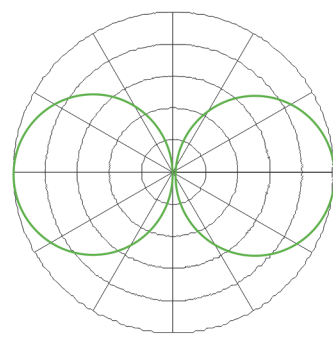

Horizontaldiagramm
Frequenz: 9 kHz
bis 20 MHz

Horizontal pattern
Frequency: 9 kHz
to 20 MHz

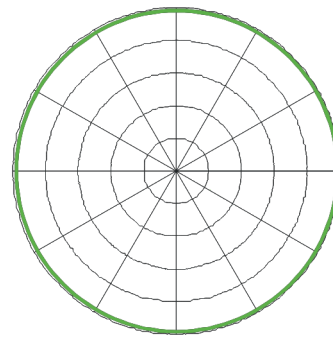

Vertikaldiagramm
Frequenz: 9 kHz
bis 20 MHz

Vertical pattern
Frequency: 9 kHz
to 20 MHz

Fig. 5-17: Radiation patterns of the optional antenna module R&S HE300HF, 9 kHz to 20 MHz.

6 List of Appendices

Appendices:

- Drawing 4067.5900.01 D, sheet 1